

ALARM MEMORY FUNCTION

The smoke alarm will remember if it has been triggered for a period of 48 hours. The red LED (Yellow LED if hardwired) indicator flashes 3 times every 48 seconds during that period.

To identify the triggered alarm on a interconnected system press the locate button on the Emerald Smoke Alarm Controller (sold separately) and the triggered smoke alarm will starting alarming.

If smoke alarm has been turned off for 48 hours it will delete this history.

WRONG WIRING REMINDER

Smoke alarm will chirps once every 2 seconds to warn a wrong wiring. Correct the wrong wiring immediately and test the interconnection. Replace a new one if smoke alarm has been damaged.

ROUTINE MAINTENANCE

Like other electrical accessories in the home, smoke alarms require maintenance to ensure efficient and effective operation. Proper maintenance can also reduce the likelihood of false alarms.

Warning: Electrical shock hazard. Disconnect the AC mains at the fuse box or circuit breaker powering the alarm before following the cleaning instructions.

1. In addition to monthly testing, the alarm requires cleaning at least once a month to remove dust, dirt, or debris.
2. Using a vacuum cleaner with the soft brush vacuum all sides and cover of smoke alarm device.

Note: Do not attempt to remove the cover to clean inside. This will affect warranty.

Warning:

1. Photoelectric smoke detectors can reduce the likelihood of a disaster, but they cannot guarantee a 100% safety.
2. To ensure your maximum security, please install all smoke detectors exactly according to this manual.
3. Keep the detectors clean. Do not allow dust to accumulate and test them at least once a week.
4. If they are not working properly replace them immediately.

HOW TO DEACTIVATE THE SMOKE ALARM

The best way to deactivate the alarm is to open the alarm and follow the instructions on the yellow label.

To open the alarm press the "Push to Open" button on the side of the alarm.

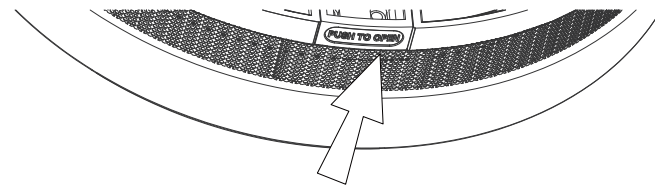

Press TEST 6 times within 3 seconds. The smoke alarm will chirp when the alarm has been deactivated.

There will be no alarm functions while in this status. You must reactivate the alarm before use.

Warning: Deactivating this alarm should only be performed if you need to dispose of the smoke alarm or if you need to cease a nuisance alarm which is caused by a failure of the smoke alarm.



SMOKE ALARM USER MANUAL

MODEL NUMBER: EP-HYB-240-10

Thank you for choosing Emerald Alarms.

This leaflet contains important information on the correct installation and operation of your smoke alarm.

Please read all the information before commencing installation and retain for future reference.

This unit has been designed to meet the latest safety standards demanded in Australia and complies with the requirements of AS3786:2014.



DIMENSIONS	140 x 45mm
WEIGHT	257.5g, 264.9g with RF module
WARRANTY	10 years
MOUNTING OPTIONS	Ceiling or wall mount
POWER	10 year non-replaceable 3V lithium battery (EVE CR17450) OR 220~240V AC 50-60Hz with 10 year non-replaceable 3V lithium battery back-up (EVE CR17450)
INTERCONNECT	Connects with up to 24 Emerald alarms when hardwired Optional wireless radio frequency (RF) technology connects with up to 40 Emerald RF enabled alarms
WIRELESS DISTANCE	>20m (100m outside)
SENSOR	Photoelectric optical chamber
SOUND PATTERN	ISO 8201
ALARM VOLUME	>85dB(A) @ 3m
ALARM SENSITIVITY	0.1-0.16dB/m
HUSH/SILENCE TIME	approx. 8 minutes
NORMAL OPERATING & STORAGE TEMPERATURE	0° to 40°
NORMAL OPERATING & STORAGE HUMIDITY	≤93% relative humidity (non-condensing)
PACK INCLUDES	Smoke alarm, instruction manual, screws and mounting plate

DESCRIPTION

The unit is a photoelectric smoke alarm device. It is particularly sensitive for detecting visible micro-particles (associated with smoldering fires) and reacts faster than ionization alarms. An example of such smoldering fires is a cigarette burning in a couch or bedding a common cause of devastating blazes.

Please note this device does not detect flames, heat, carbon monoxide or other hazardous gases. It has many advanced features and an extended operational life with the included battery.

To enable interconnection with other Emerald RF smoke alarms add an RF module (EP-HYB-RF-MOD).

WARRANTY INFORMATION

K.P.S. AUSTRALIA PTY LTD warrants this smoke alarm to the original purchaser.

K.P.S. AUSTRALIA PTY LTD warrants each new smoke alarm is free from defects in material and workmanship under normal use and service for a period of 10 years from the date of purchase.

This warranty does not cover damage resulting from accident, misuse or abuse or lack of reasonable care of the product.

In no case shall K.P.S. AUSTRALIA PTY LTD be liable for any incidental or consequential damages for breach of this or any other warranty express or implied whatsoever. Faulty product can be mailed to the following address with a detailed explanation of problem.

K.P.S. AUSTRALIA PTY LTD

20 Kikuyu Road, Chevallum QLD, 4555, Australia
support@emeraldalarms.com.au
1300 316 552

2024.11

INSTALLATION LOCATIONS

OPTIMAL ALARM PLACEMENT

For the highest level of protection, we strongly recommend installing multiple combination alarms in your home. Each alarm serves a specific purpose and adheres to certain rules and regulations.

To ensure proper installation, we advise following the state based regulations and installation requirements.

The following graphs illustrate some best practices for alarm placement:

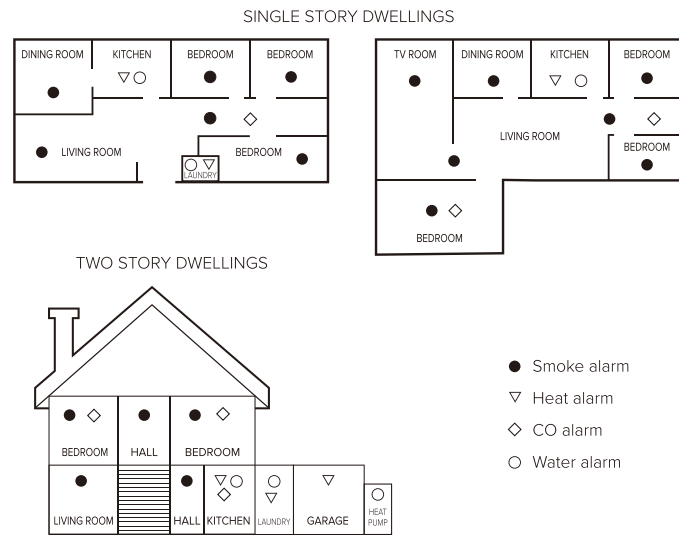

Note: These graphs are for illustrative purposes only and may not cover all potential scenarios. It is essential to assess your home's layout and potential risks to determine the most effective alarm placement.

LOCATIONS TO AVOID

1. Don't place alarms in areas prone to steam, condensation, or exposure to normal smoke and heat from appliances, such as bathrooms, kitchens, and garages. These conditions may trigger false alarms.
2. In spaces with high humidity, like bathrooms or areas near dishwashers or washing machines, ensure the alarm is installed at least 3 meters away from these sources of moisture.
3. Keep alarms at least 1 meter away from air returns or heating and cooling supply vents. Airflow from these vents can disrupt the smoke detector's performance by blowing smoke away from it.
4. Do not install alarms in rooms where the temperature may drop below 0°C or exceed 40°C, as extreme temperatures can lead to nuisance or false alarm activation.
5. Avoid placing alarms in extremely dusty, dirty, or insect infested areas, as particles in these environments may interfere with the proper operation of the alarm.
6. Away from air conditioning or ventilation grilles/louvers.

POSITION OF SMOKE ALARMS

Smoke will spread horizontally after rising to the ceiling so it's advisable to install the smoke alarm in the centre of the ceiling where possible. Avoid areas where there is no circulation.

- When mounting an alarm on the ceiling, locate it a minimum of 30cm from the side wall.
- When mounting an alarm on the wall, position it a minimum of 30cm from the corner and a maximum of 50cm below the ceiling. Position hinged opening on the side.
- Install smoke alarm/s on sloped, peaked or cathedral ceilings between 50cm and 250cm from the highest point of the ceiling.

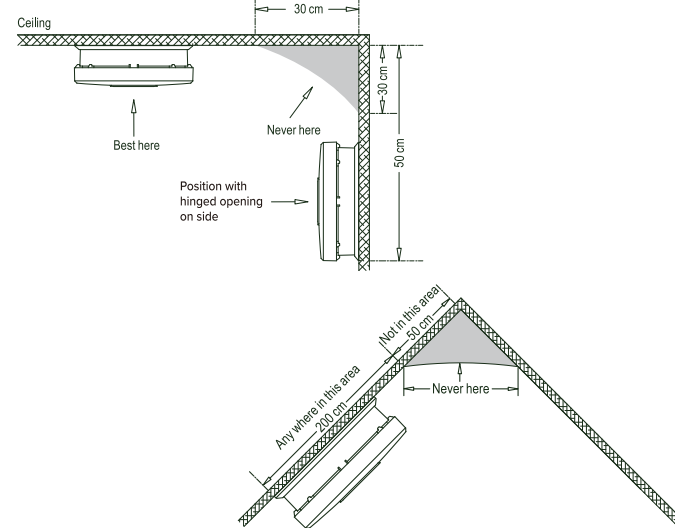

ASSEMBLY

Failure to follow these instructions may result in injury and equipment damage/malfunction.

1. 240V hardwired smoke alarm/s must be installed by a licensed electrician and securely attached to the ceiling in accordance with the installation instructions.
2. All interconnected smoke alarms must be supplied from the same circuit.
3. A common neutral must be used for the interconnect to operate.
4. DO NOT connect the interconnect wire to active or neutral.
5. A maximum of 24 smoke alarms can be installed on one circuit (wired interconnection only).

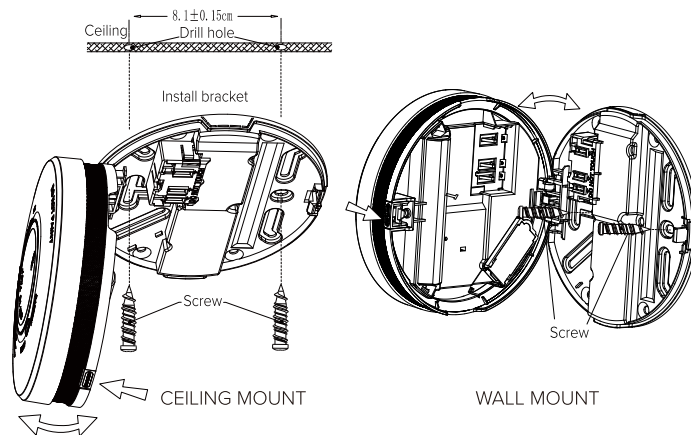

ACTIVATION

Press and hold the "Push to Test" button for 5 seconds until the red LED lights up, release the button within 2 seconds. You'll hear a "beep" sound, indicating the alarm is activated.

INTERCONNECTING SMOKE ALARMS

This smoke alarm offers a wired interconnection function. Interconnecting smoke alarms can be linked together so that if one alarm is activated all alarms linked on the circuit also sound.

Note: A 3V signal is applied to all interconnected wired smoke alarms. The maximum wiring length is 150m between smoke alarms.

INTERCONNECTION WIRING DIAGRAM

(A) Active (E) Earth Loop (N) Neutral (I) Interconnect

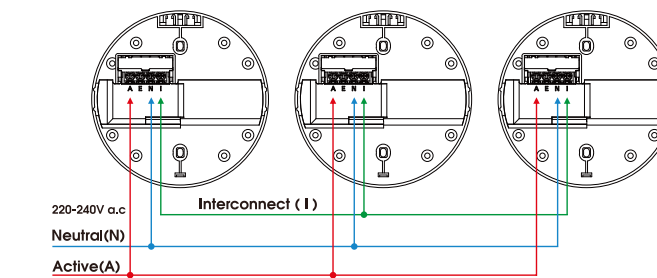

WIRE CONNECTION

1. Strip the active, neutral and interconnect (if used) wires back to the strip length.

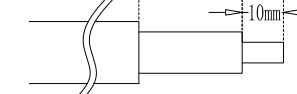

2. Connect the wires to the correct terminals on the base and ensure terminal screws are fully tightened. Check all wires are secure and not cross connected to either active or neutral terminations.

Ensure the terminal cover is closed to avoid contact with the active terminal.

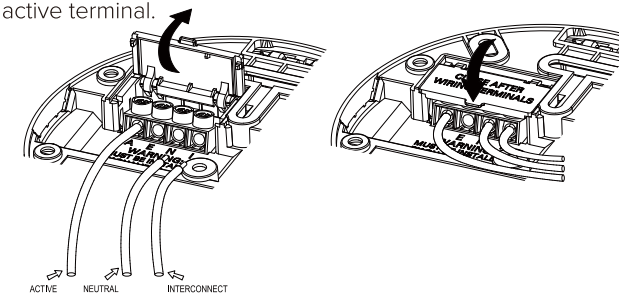

3. Screw the mounting base onto the ceiling using the supplied fittings.
4. Clip the smoke alarm onto the base.
5. Turn on the mains power and check the smoke alarm's green and red LED. Green LED should illuminate to indicate mains power is on. Red LED will pulse every 48 seconds indicating the alarm is working with the mains power supplied. The yellow LED will flash once every 48 seconds indicating the alarm is powered by battery power supply. In case of a low battery the yellow LED will flash once every 48 seconds with an audible chirp.
6. Press the Test/Hush button to check the smoke alarm is working.

Warning: Installation is not complete until both LEDs are functioning correctly and the alarm has been checked for correct operation. Wiring must be installed in compliance with local regulations.

Use a minimum of 1.0mm 2 250V insulated wire for all wiring, including interconnecting wiring.

Terminal Provisions: active, neutral, loop and interconnect terminals, each accommodates 2x1.5mm².

OPERATION AND TESTING

Smoke alarms are an important safety device in the home. It is important to check them regularly to ensure they are operating correctly.

Regular Mode

When there is no smoke present the green LED light remains on and the red LED should flash every 48 seconds to show the alarm is active.

Alarm Mode

When the alarm detects smoke, the red LED will flash once per second and the alarm will sound loudly. The flashing LED and alarm will continue until the air is cleared.

Fault Mode

The alarm will generate a 'chirp' every 48 seconds without any light flashes indicating a fault.

TESTING YOUR SMOKE ALARM

It is recommended that you test your smoke alarm once a month to ensure the smoke alarm is working correctly. Test by pushing the test button on the cover. Holding the test button for 5 seconds will test all interconnected alarms. The alarm(s) will sound if the alarm, electronic circuitry and battery are working. If no alarm sounds, the smoke alarm has a defective battery, or another fault.

Warning: Do not use an open flame to test your alarm. You could damage the alarm or ignite combustible materials and start a structure fire.

LOW BATTERY POWER

Should your smoke alarm have a low battery the unit will emit an audible 'chirp' once every 48 seconds and the yellow LED light flashes once at the same time. When this occurs you must replace the smoke alarm immediately. Your smoke alarm will continue to warn of this low battery for at least 30 days. However, failure to change the smoke alarm after this time would mean your smoke alarm may have insufficient power to alert you in a real fire situation.

Warning: Your smoke alarm requires the 3V DC battery to have sufficient capacity of power to operate correctly.

SILENCE ALARM

If your smoke alarm emits the full alarm signal and you are not testing the unit, the smoke alarm is warning you of a potentially dangerous situation that requires your immediate attention. Only use the alarm silence function after making sure that there is no ongoing fire emergency situation.

Do not block the vents on the alarm or disable the smoke alarm in any way as this will remove your protection.

Smoke alarms can sometimes react to cooking fumes or other non emergency situations. In the event of a known false alarm your smoke alarm can be temporarily silenced by pressing the HUSH button. Your alarm will automatically return to full sensitivity within 8 minutes.

1. Press and release the HUSH button, the alarm sound will stop.
2. Your alarm will silence and enter into a reduced sensitivity reset cycle for approximately 8 minutes.
3. During the reduced sensitivity reset cycle, the red LED will flash every 8 seconds indicating it is running in silent mode.
4. Your alarm will automatically return to full sensitivity on completion of the reset cycle and the red LED will revert to flashing once every 48 seconds.

Warning: Never ignore any alarm. Ignoring the alarm may result in injury or death. If your smoke alarm activates and you are not absolutely certain of the source of the smoke, get everyone out of the house immediately.